

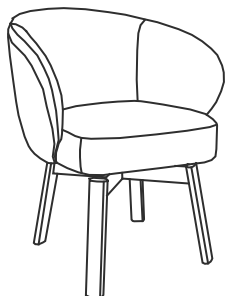









# sømcasa

# ASSEMBLY INSTRUCTION



ITEM	PART	NAME	QUANTITY
(A)		SEAT	1
(B)		LEG	2
(C)		TURNPLETE	1
(D)		IRON SHEETS	1
(E)		BOLT M6*20mm	4
(F)		BOLT M6*75mm	4
(G)		WASHER M6*18*1.2mm	8
(H)		PLASTIC PAD	4
(I)		ALLEN KEY	1

STEP 1:

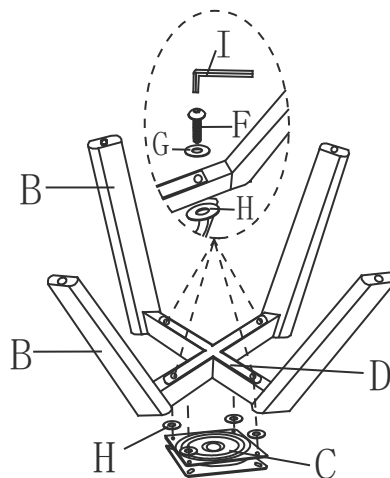

STEP 2:

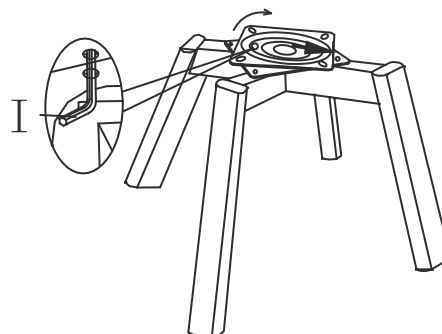

STEP 3:

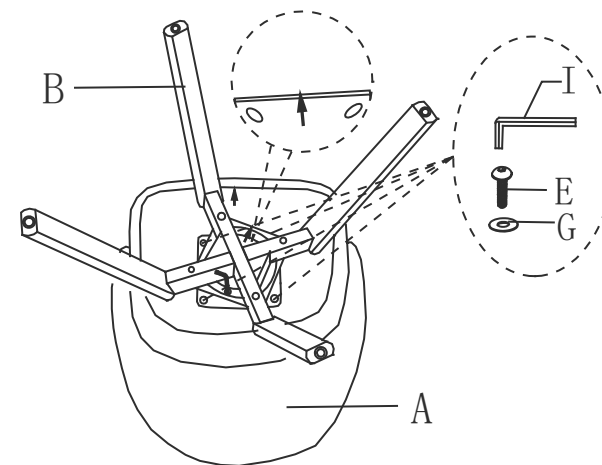

STEP 4:

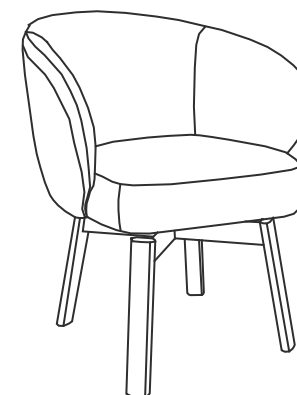

NOTE:

PLEASE PUT THE CHAIR ONTO A SOFT AND CLEAN SURFACE FOR ASSEMBLY.