



REF	DESCRIPTIONS	QTY	A. Flat Washer 8mm	B. Allen Bolt 6X20mm	C. Allen Bolt 6X16mm	D. Allen Key 4mm
1.	TABLE TOP	1				
2.	LEG A	1				
3.	LEG B	1				
4.	METAL PLATE A	1	8+1Extra	8+1Extra	6+1Extra	1 Pc.
5.	METAL PLATE B	1				

PARTS



Step 1.

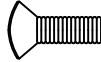
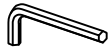
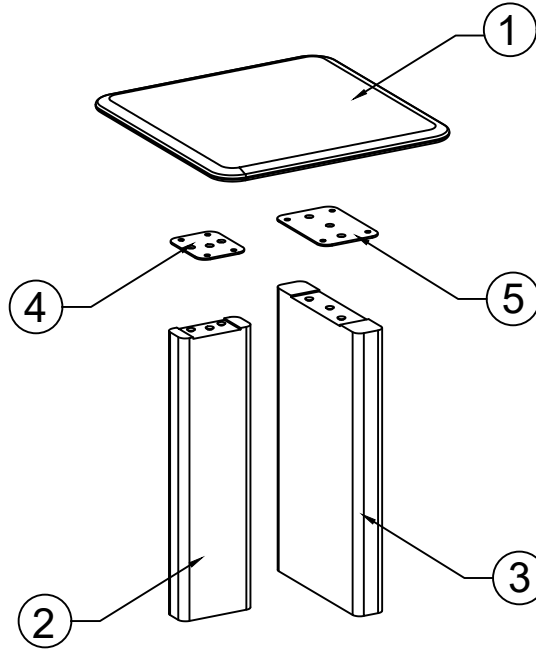
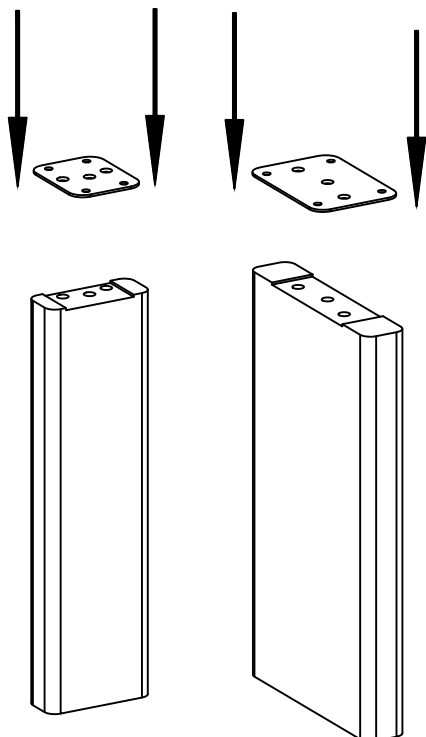

Step 2.

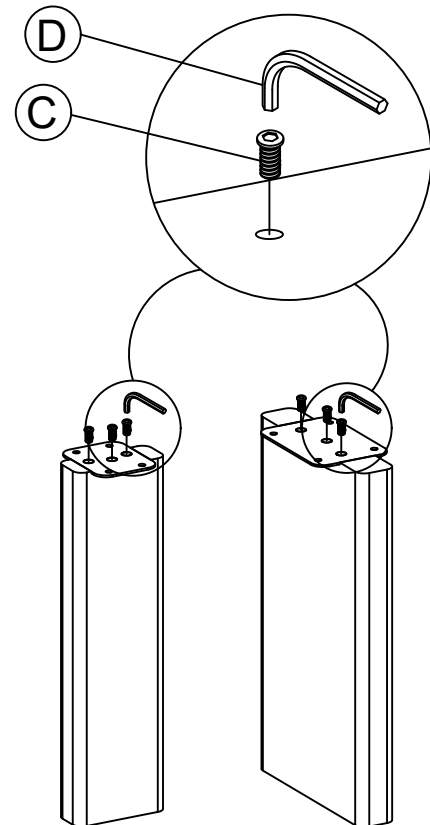

Step 3.

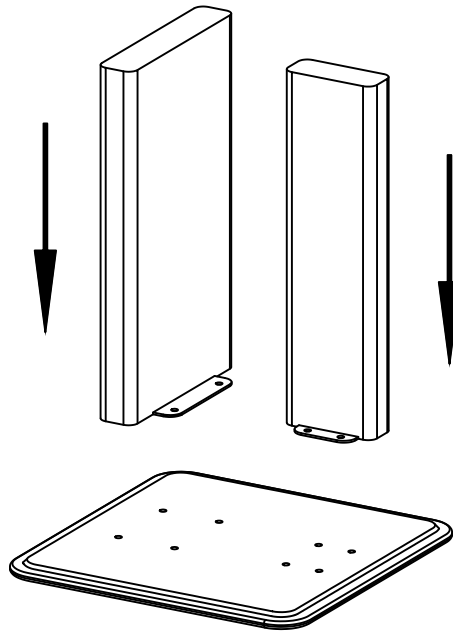

Note :- Place top on a clean and dry surface.

Step 4.

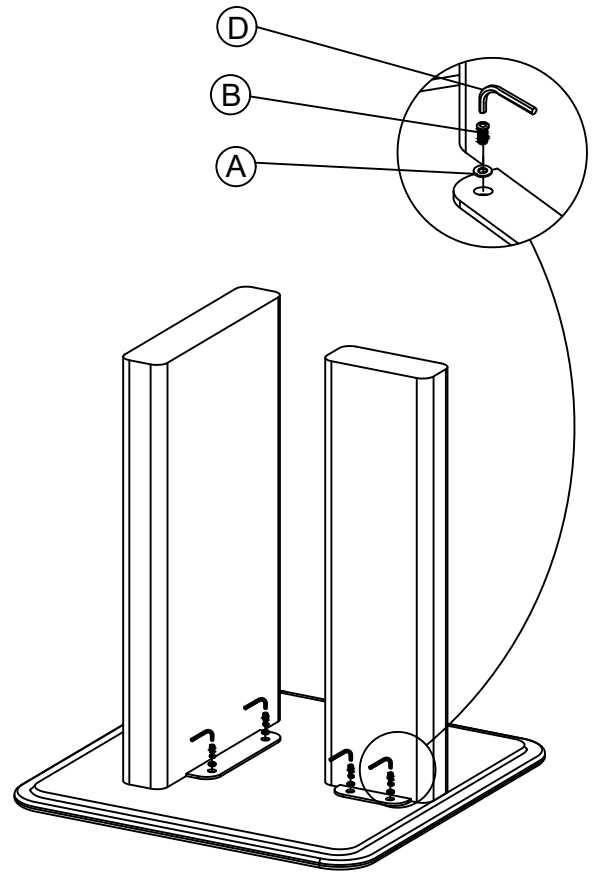

Finish.

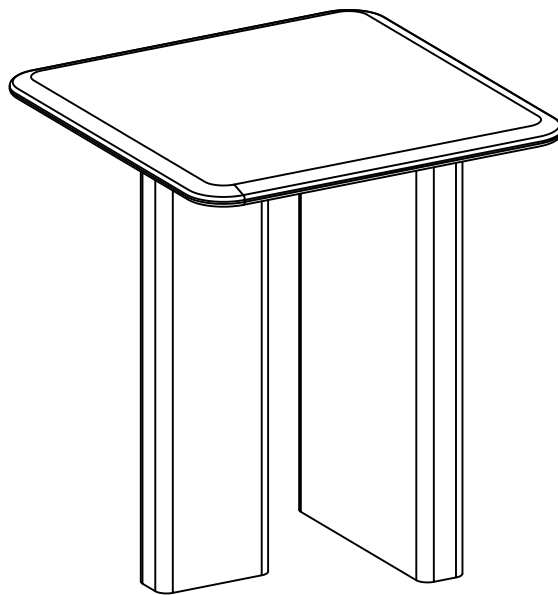

The Table is now ready to use.